



## Design and Implementation of a Development Environment on Ladder Diagram for Arduino with Ethernet Connection

---

Héctor Iván Inzunza Villagomez, Beatrice Pérez Arce,  
Sergio Iván Hernández Ruiz and José Alejandro López Corella

EasyChair preprints are intended for rapid dissemination of research results and are integrated with the rest of EasyChair.

July 3, 2018

# DESIGN AND IMPLEMENTATION OF A DEVELOPMENT ENVIRONMENT ON LADDER DIAGRAM FOR ARDUINO WITH ETHERNET CONNECTION

Inzunza Villagomez Héctor Iván <sup>1</sup>, Pérez Arce Beatrice <sup>2</sup>, Hernández Ruiz Sergio Iván <sup>3</sup> and López Corella José Alejandro<sup>4</sup>

Tecnológico Nacional de México / I.T. de Nogales, Metal Mecánica Ingeniería Mecatrónica  
Av. Tecnológico 911, Nogales, Sonora, México  
+52(631) 311 1881. Ext 1129.

[sergiohernandez@itnogales.edu.mx](mailto:sergiohernandez@itnogales.edu.mx), [lopez.alejandro@itnogales.edu.mx](mailto:lopez.alejandro@itnogales.edu.mx)

**Abstract** The purpose of this project is to present an alternative for the Arduino boards programming through a ladder diagram development environment. Similarly, it seeks to provide a new option for both academic and automation process applications for effective solutions without the use of extensive resources. The product of this objective is a PLC with Ethernet connection prototype based in Arduino, which is distinguished by being compact, economical and easy to control. It's programmed through an IDE, developed by Visual Studio with the C# programming language and has basic and intuitive tools for program development and also has a single and friendly interface to ease its use.

**Keywords** Arduino, C#, Ladder Diagrams, PLC, Visual Studio.

## I. INTRODUCTION

In modern industry, automation is one of the pillars that sustains the production of most of the products we regularly consume and use, from canned juices to the cars in which we move [1].

The automated processes are systems that facilitate the control of serial productions, because they speed up the transfer and development of activities, as well as the assembly or coating with paints of the products. They can also reduce long-term costs, since human error detections are usually easy to control and calibrate.

The control systems are responsible for controlling the automation processes, and the latter are as important for the process as are the engines for the automobiles. With the advance of technology, control systems have evolved, increasing their versatility to adapt to various processes, reducing their size and complexity.

The aforementioned benefits have attracted certain leaders or business leaders who are interested in having more precise control when offering or selling their products and / or services. However, a limitation that is usually presented for those small business owners who want to improve production

H.I. Author, is with the Tecnológico Nacional de México / I.T. de Nogales, Nogales, CP84065 México ([hector\\_inzunza@itnogales.edu.mx](mailto:hector_inzunza@itnogales.edu.mx)).

B.P. Author, is with the Tecnológico Nacional de México / I.T. de Nogales, Nogales, CP84065 México ([Beatrice\\_perez@itnogales.edu.mx](mailto:Beatrice_perez@itnogales.edu.mx)).

and performance processes through automation, is the high cost of controllers, such as programmable logic controllers.

A programmable logic controller (PLC) is a computer that is used to automate electromechanical processes. They are characterized by being practical to program and modify, avoiding additional costs and saving time in the preparation of projects. Ladder language, also known as Ladder language or contact diagram, is the most popular in the industry for programming [2,3].

Currently PLCs are widely used in the industry due to their versatility, and a very common tool available to these controllers is the Internet connection.

In recent years the presence and importance of the internet has grown disproportionately. The ease of access to information and transmission of data have extended the horizons of users, since creating new projects that were previously unthinkable or limited by resources, are now possible, from the control of databases, control and visualization of processes of production until the intercommunication of users and machines in the industry.

## II. REFERENCE FRAME

### A. Arduino.

Arduino is a company that manufactures development boards based mostly on Atmel AVR microcontrollers. Said plates are printed circuits that facilitate the handling of the peripherals of the microcontrollers.

Similarly, the Arduino company offers a development environment (IDE) where users can program the microcontroller of the board with a computer. This IDE is open source and is based on the processing environment and structure of the Wiring programming language [4,5].

The Ethernet connection on the Arduino board is achieved through a Shield, this is a device that is assembled on the development board.

### B. Visual Studio.

Microsoft Visual Studio is a development environment that

offers tools and services to create applications and websites for any platform. This IDE can work with multiple programming languages, such as C ++, C # and java. The applications created in this environment have a wide range of tools that allow, the manipulation, elimination and creation of files and databases, serial communication with different devices and the exchange of information with other programs [6].

### C. Programmable Logic Controller (PLC)

A PLC is a programmable automaton designed for the control of industrial processes following the instructions of a program loaded in the memory of the device. Unlike a commercial computer, these devices control multiple peripherals where equipment, machinery and / or electrical and electronic components can be connected. But like a PC these computers can have large storage and information processing capacities [2,7].

### D. Ladder diagram.

Ladder diagrams are also known as ladder logic and ladder language. It is a standardized graphic language for the programming of logic controllers and is based on the classic electrical control schemes (Fig.1). One of the advantages of ladder language is its easy understanding for a technician or engineer. For the construction of these diagrams, multiple tools are used, such as open contacts, closed contacts, timers, among others [2,7].

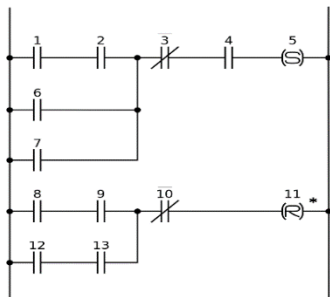

Fig. 1. Example language ladder.

## III. PROPOSED SOFTWARE.

### A. HT-PLC (IDE).

HT-PLC is a software, developed in Visual Studio, that allows the creation of ladder diagrams to be loaded and executed on an Arduino board.

The program contains tools that allow PLC communication through a serial communication port on the computer.

### B. General characteristics.

The IDE has the option of creating projects that can be saved in the computer's memory, as well as allowing the modification of files and sending them to the PLC if desired. For the elaboration of these the IDE has tools, work sections, and an intuitive environment (Fig.2 and Fig. 3).

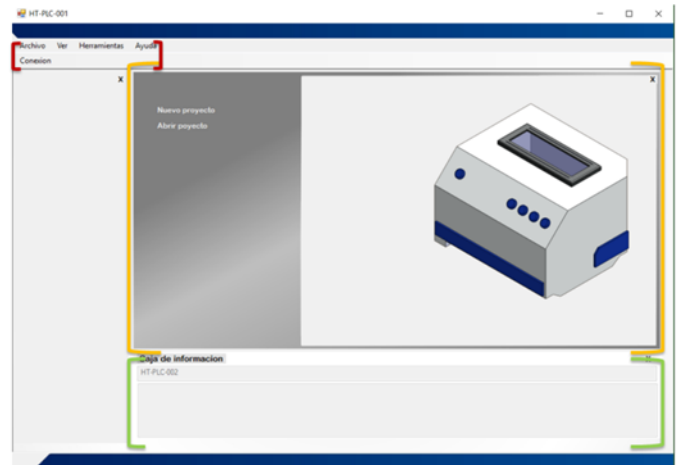

- Accesos directos, herramientas y ayuda
- Menú principal
- Caja de información

Fig. 2. Start Menu.

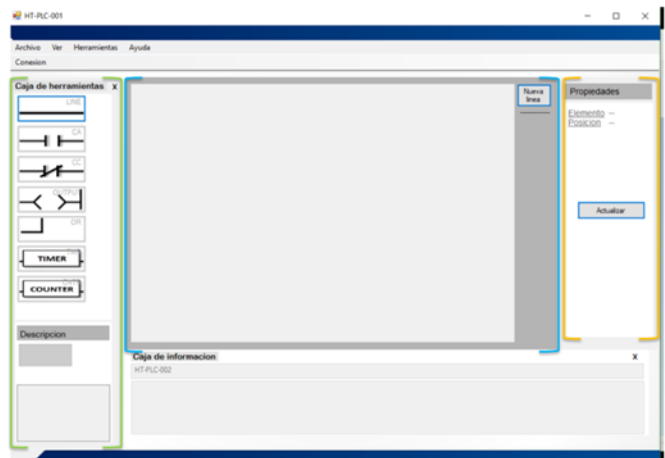

- Caja de herramientas
- Sección de programación
- Caja de propiedades

Fig. 3. Work sections.

### C. Records.

A register is a memory space where you can read and / or write binary information to interact with PLC peripherals.

There are 5 types of records in this platform, each of which is responsible for managing different functions (Table I).

TABLE I  
PROGRAM RECORDS

<b>Record "A/a"</b> output (L/E) (1 a 8)	Receives the control function of outputs.
<b>Record "B/b"</b> inputs (L) (1 a 8)	Show data inputs.
<b>Record "C/c"</b> Internal coils (L/E) (1 a 77)	It is responsible for activating and deactivating the internal coils.
<b>Record "e"</b> Timer (L)	It is responsible for reading the timer events.
<b>Record "d"</b> Counter (L)	Gets the information of the counter events.

D. Toolbox.

The toolbox is the section of the program in which the tools for the construction of the staircase diagram are located. It appears automatically on the screen when selecting the option to create a new project or to open an existing one, leaving in full view the tools that can be used (Table II).

TABLE II  
CLASSIFICATION OF TOOLS

Control Tools	
Contact Open (CA) / Contact Closed (CC)	The contacts serve for the specific reading of the position of a bit of a register. If the bit in question is equal to "1" the closed contact will open, and if it is an open contact, it will be closed. If the bit in question is equal to "1" the closed contact will open and / or open contact will be closed. Otherwise, in which they receive a bit with value "0", they will remain in their normal, open and closed state respectively.
Output (OUT)	The output element deals with writing the position of a bit of a register.
Union tools	
Líne (LINE)	The line is a tool that can erase any of the other resources placed in the programming section.
Union "OR" (OR)	The union "OR" enables the link of one or more lines to another.
Event tools	
Timer (TMR)	The timer is the one that momentarily activates the position of the "e" record when a certain time passes, at the moment when the event has been repeated a certain number of times, the other position of the same record is activated. The user is the one who defines the duration and the repetitions of the timer.
Counter(CNTR)	The counter sends a bit "1" in the "d" register when a certain number of cycles has been activated, defined by the user.

E. Programming section.

The programming section (Fig. 4) is one that is dedicated to the construction of ladder diagrams. When starting a new

project, the area will appear blank and, to start working, it is necessary to press the "New line" button each time you want to add a new line.

The section is divided into lines composed of 8 blocks, in which one of the available objects can be assigned. In turn, the blocks are divided into two groups: 7 of reading located on the left side, being able to assign only the resources of CA, CC, LINE and OR; and the last one of writing that is located in the right side, in which only the tools OUT, TMR and CNTR can be inserted.

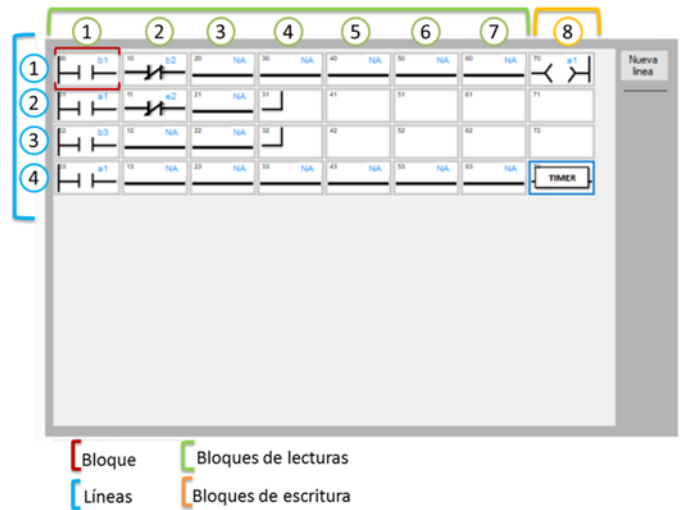

Fig. 4. Programming section.

F. Property box.

The property box assigns the information with which each block will work, depending on the selected element. The control tools will write or read a specific position of a record and likewise can be designated to a coil, if allowed by the chosen object. To indicate this registration, it is mandatory to enter a letter followed by a number in the text box called "Coil", located in the property section. The letter represents the record and the number declares the reading position. In the case of union tools, it is not possible to enter or edit any type of information.

On the other hand, event tools accept data entry, whose options or variables change by the type of event. In the timer it is necessary to establish two values: the value of the interval, which defines the time in which the first bit of the "e" register will have the value of "1"; and the value of repetitions, which establishes the number of occasions in which the timer interval is repeated to put the second bit of the record "e" in "1". The counter only specifies the number of times that must be activated momentarily to set the first bit of the "d" register to "1".

### G. Information box.

The information box is at the bottom of the screen. This provides information on operations and errors that may occur, such as connection failures, data updates, among others. In order to assist the user in the occurrence of errors, an option called "List of errors" has been placed in the help section containing the description and the reasons why they occur.

### H. Construction of the ladder diagram.

The preparation of a contact diagram consists of a series of very simple steps: the first is to open a new project from the main menu or in the "File" tab; the next is to place a new line by pressing the "New line" button in the programming section; then the tools are introduced in the blocks, which is achieved by clicking on the element and another click in the space that is preferred; what follows is to determine the information of the block by selecting it with the cursor, showing the box of properties that will give us access to the editable aspects of the object; Finally, the "Update" button is pressed in the same section and the values are reflected in the information box.

After the conclusion of the diagram, the program can be saved in the computer's memory as a text file, for this it is selected in the tab "File" where it says "Save". So if you want to open a saved program you go back to the "File" tab and choose the "Open" option, or alternatively you can go to the main menu and load the file.

### I. CONNECTION WITH THE HARDWARE.

The connection of the computer to the Arduino is done through the use of a USB cable (Type A-B) that are connected to their respective inputs. When in contact, in the "Port" section, look for the "Connection" tab and click to choose the Arduino serial port. There is a possibility that it does not appear and, if so, you must press the "Update" button. In case the serial port has been established, all you have to do is click on "Connect" and successfully complete the connection. If the programmer decides to load the programming to the hardware after doing the above, it is only necessary that the "Load project" button be pressed.

## IV. HARDWARE.

### A. HT-PLC-001.

To facilitate the use of an Arduino board as a programmable logic controller, a PLC prototype based on this

microcontroller, called "HT-001", is offered. Although the program can be adapted to any brand plate, this prototype is controlled by an Arduino one and an Arduino nano with the purpose of expanding the peripherals.

The software programs can be loaded into this controller, which are stored in the EEPROM memory of the microcontroller, this means that once the program is loaded, even if the PLC restarts the last loaded program it will not be lost, but it will be erased. load a new one

### B. Functioning.

The HT-001 has an "H bridge" module used as a voltage regulator to power an Arduino one, an Arduino nano, a 20x4 LCD screen and an 8-relay module (Fig. 5). The Arduino one prints the information of the menu in the LCD screen, receives the information of the digital entrances and sends the information of the state of the relays to the Arduino nano, while this responds with the information on the states of the buttons.

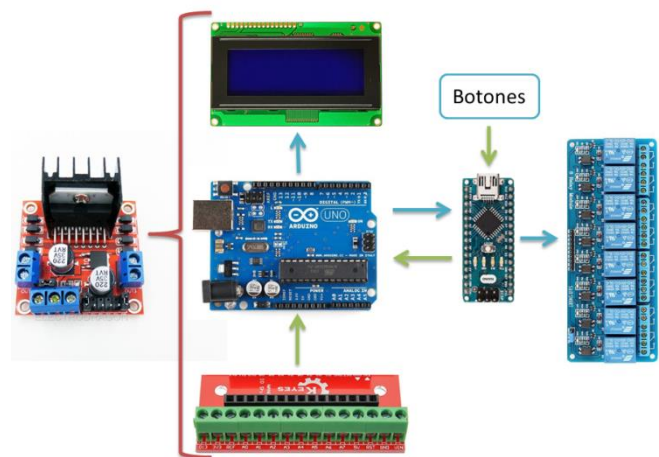

Fig. 5. Internal structure of the PLC.

### C. Structure and control.

This PLC has a total of 8 digital inputs, 8 relay outputs, 5 buttons for menu control, a pair of LED lights, Ethernet connection, an on / off button, an input for 12V power and a screen LCD (Fig. 6).

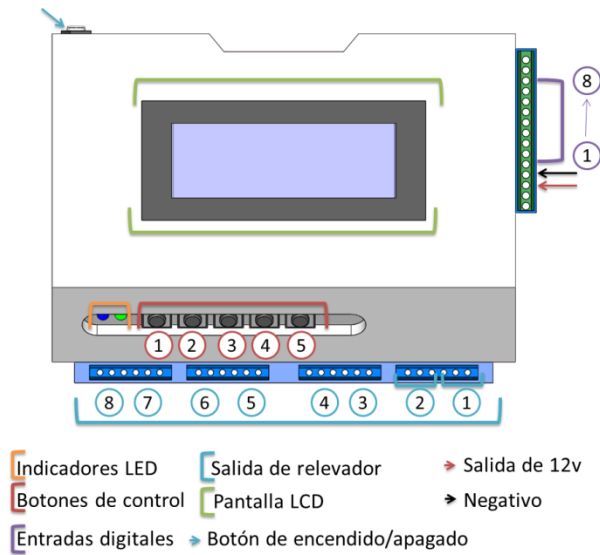

Fig. 6. PLC physical structure.

To turn on the controller, it is necessary to connect to a 12V alignment source and then press the power button on the back. If the green LED turns on and off four times in equal intervals, it indicates that the PLC is working correctly, and if the blue LED stays on it indicates a correct power supply.

#### D. screen.

The controller has a 20x49 LCD screen (Fig. 7) which is divided into 4 lines. The first line on the far right can be seen if a program is running or not. In the second and third lines are the menu options. And on the fourth line you can see which buttons are pressed.

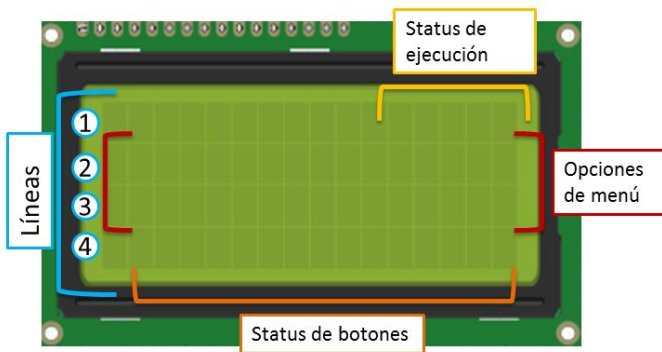

Fig. 7. PLC LCD screen.

This interface is divided into the main menu (menu 1) and the secondary menu (menu 2), each menu has two options.

The PLC always starts with menu 1, where the options of "Read program" and "Status" are found, while in menu 2 there are the options of "Delete program" and "Execute program".

#### E. Buttons.

Button 1 is used to select the desired option. Buttons 2 and 3 allow the user to move between menu 1 and menu 2, and finally buttons 4 and 5 serve to raise and lower the selection cursor.

#### F. Options.

To be able to use the "Read program" option, the PLC has to be previously counted to the PC, and it serves to receive a new project from it. It is automatically stored in the EEPROM memory of Arduino.

The option of "Status" serves to see in real time the status of some registers, such as the records of exits, entrances, etc. When this option is running, the information in the registers is also automatically sent to an internet page when the PLC is connected to a network.



The option "Delete program" that is inserted in the second line of menu 2 deletes the last program loaded from the EEPROM memory, leaving it completely empty. To execute a previously loaded program it is necessary to go to the option of "Execute program", once selected, the program is executed automatically and to stop it is only necessary to select the same option.

## V. RESULTS

For the operation of Arduino as PLC only an Arduino board with a shield that allows an Ethernet connection is needed, however, the prototype HT-PLC facilitates the control of the peripherals and does not need a previous configuration for its operation, the only thing that requires is to have a loaded program for reading and executing the programs created in the software.

Table III compares two programmable logic controllers that are currently on the market and have similar basic resources.

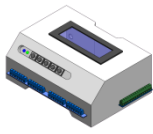
TABLE III  
PLC COMPARISON

Model	HT-PLC-001	LOGO! 0BA7	PLC Micro810
			
Inputs	8	12	8
Outputs	8	8	4
Basic tools	5	8	
Special Tools	2	30	
Hardware costs	450	2700	4700
Ethernet connection	Si	No	Si

## VI. CONCLUSIONS.

The objective of this work was to develop a platform (software-hardware) that would allow the programming of Arduino cards in ladder language for the later application of this microcontroller as a PLC. It presents in a general way the context and the minimum requirements necessary for the functioning and communication of the system, fulfilling satisfactorily.

In the future we intend to integrate the Wifi Shield card into the device, in order to provide the platform with network connection capabilities and thus a greater adaptability to the needs and processes of industrial production, specifically industry 4.0.

## VII. REFERENCES.

- [1] Enrique Mandado Pérez, “Autómatas programables y sistemas de automatización” Ed. Marcobo, 2009, ISBN-13: 978-84267-1575-3.
- [2]<https://www.idec.com/caen/products/Catalogs/Software/AO/overview.html>
- [3] López Corella José, Automatización del proceso de moldeo por inyección de plásticos de la maquina BOY 25D, Congreso Internacional en Ingeniería Electrónica Electro 2017, Vol. 39, pp. 11-16, ISSN 1405-2172.
- [4] <https://www.arduino.cc/>
- [5] Hernández R. Sergio, Sistema Distribuido con Arduino, wifi y LabView, utilizando el protocolo UDP, congreso Internacional en Ingeniería Electrónica Electro 2017, Vol. 39, pp. 22-26, ISSN 1405-2172.
- [6]<https://www.visualstudio.com/?rr=https%3A%2F%2Fwww.google.com%2F>
- [7] <https://ab.rockwellautomation.com/>